

MICROPHONE BRIDGING TRANSFORMER TRIPLE FARADAY SHIELDS FOR HIGH ISOLATION

- Provides 2 additional, isolated balanced outputs as mic "splitter"
- Stops "ground loop" problems when a mic feeds multiple preamps
- High common-mode rejection: 130 dB at 60 Hz
- Excellent frequency response and time domain performance
- Low insertion loss: 1.2 dB

This transformer is designed for drive from a 150 Ω microphone source and for each secondary to be loaded by the 1 kΩ input impedance typical of microphone preamplifiers. A pair can be used to make a passive matrix when using the M-S stereo microphone technique. A 30 dB magnetic shield package is standard.

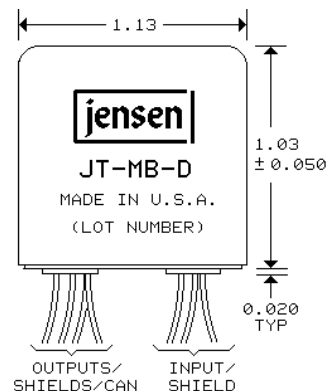

#30 AWG (7x38) UL STYLE 1061 COLOR CODED WIRE LEADS, 8" MINIMUM LENGTH

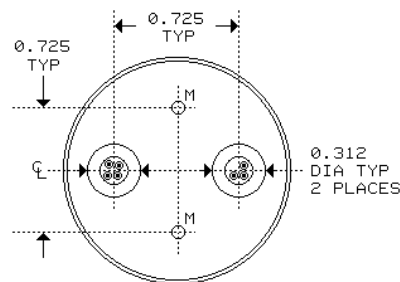

BOTTOM VIEW

USE ONLY #4 TYPE B SELF TAPPING SCREWS IN HOLES "M". ALLOW NO MORE THAN 0.15" PENETRATION INTO TRANSFORMER HOUSING.

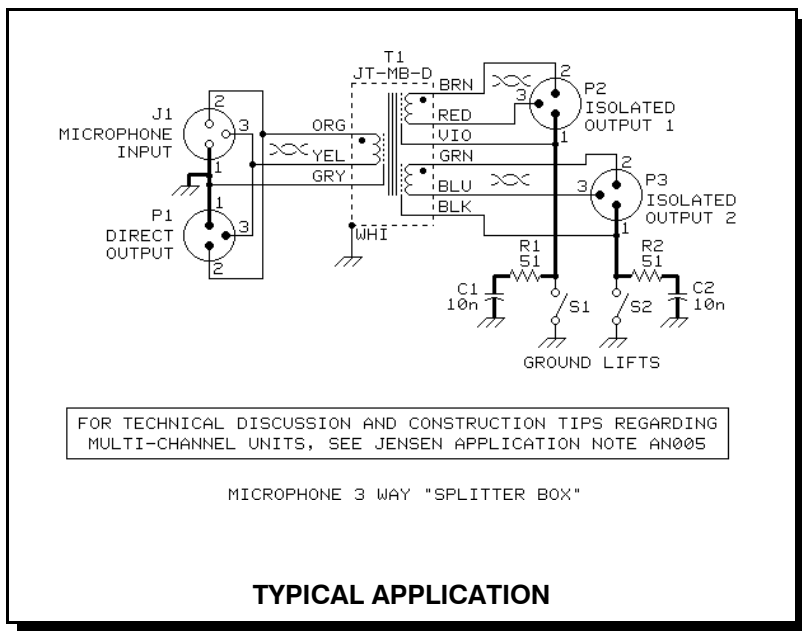

FOR TECHNICAL DISCUSSION AND CONSTRUCTION TIPS REGARDING MULTI-CHANNEL UNITS, SEE JENSEN APPLICATION NOTE AN005

MICROPHONE 3 WAY "SPLITTER BOX"

TYPICAL APPLICATION

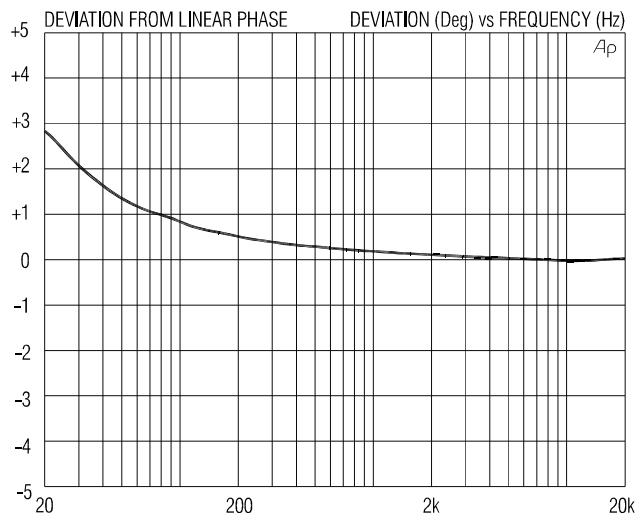
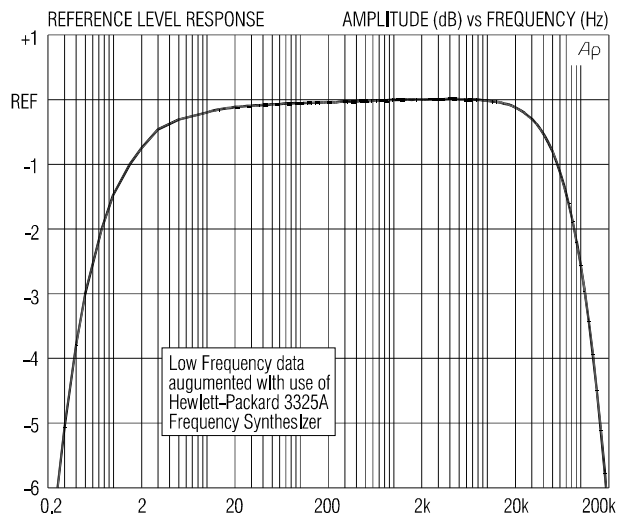

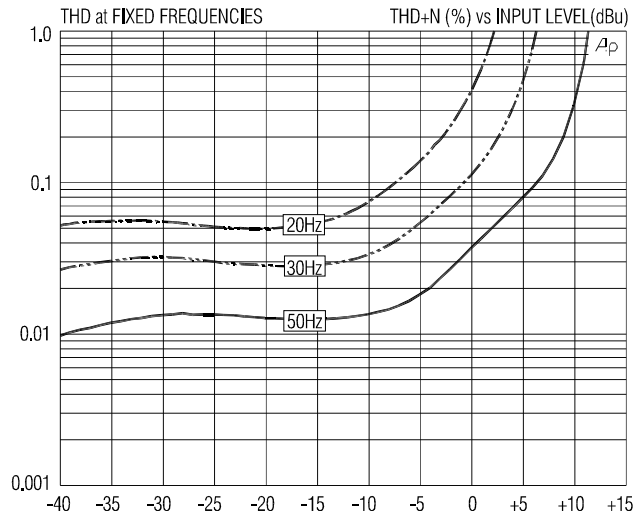
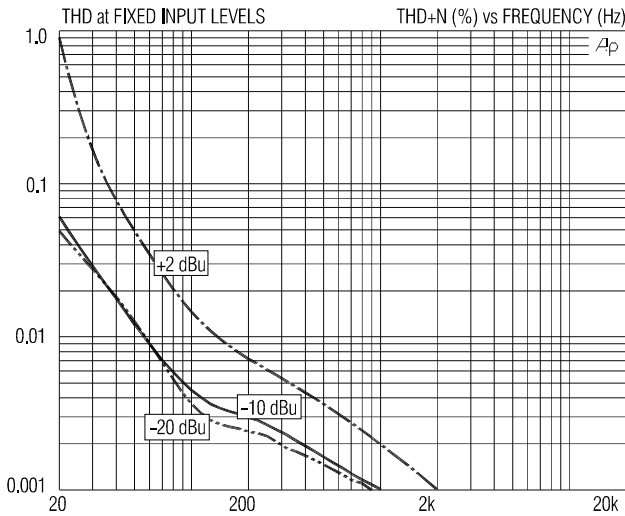

JT-MB-D SPECIFICATIONS (apply to either secondary, all levels are input unless noted)

PARAMETER	CONDITIONS	MINIMUM	TYPICAL	MAXIMUM
Input impedance, Zi	1 kHz, -20 dBu, test circuit 1	570 Ω	578 Ω	590 Ω
Voltage gain	1 kHz, -20 dBu, test circuit 1	-1.4 dB	-1.2 dB	-1.0 dB
Magnitude response, ref 1 kHz	20 Hz, -20 dBu, test circuit 1	-0.50 dB	-0.12 dB	±0.0 dB
	20 kHz, -20 dBu, test circuit 1	-0.25 dB	-0.14 dB	+0.1 dB
Deviation from linear phase (DLP)	20 Hz to 20 kHz, -20 dBu, test circuit 1		+2.8/-0°	±5.0°
Distortion (THD)	1 kHz, -20 dBu, test circuit 1		0.001%	
	20 Hz, -20 dBu, test circuit 1		0.05%	0.15%
Maximum 20 Hz input level	1% THD, test circuit 1	0 dBu	+2.0 dBu	
Common-mode rejection ratio (CMRR) 150 Ω balanced source	60 Hz, test circuit 2		130 dB	
	3 kHz, test circuit 2	85 dB	96 dB	
Output impedance, Zo	1 kHz, test circuit 1		254 Ω	
DC resistances	primary (ORG to YEL)		51 Ω	
	secondary (BRN to RED)		48 Ω	
	secondary (GRN to BLU)		54 Ω	
Capacitances @ 1 kHz	primary (ORG/YEL) to shields and case		105 pF	
	secondary (BRN/RED) to shields and case		50 pF	
	secondary (GRN/BLU) to shields and case		90 pF	
Turns ratio	primary to either secondary	1:0.999	1:1.000	1:1.001
Temperature range	operation or storage	0° C		70° C
Breakdown voltage (see IMPORTANT NOTE below)	primary or secondary to shield and case, 60 Hz, 1 minute test duration	250 V RMS		

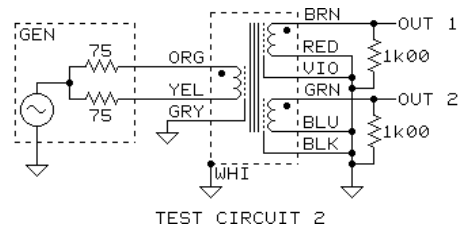
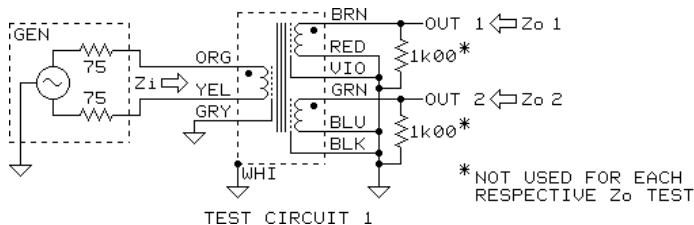

All minimum and maximum specifications are guaranteed. Unless noted otherwise, all specifications apply at 25°C. Specifications subject to change without notice. All information herein is believed to be accurate and reliable, however no responsibility is assumed for its use nor for any infringements of patents which may result from its use. No license is granted by implication or otherwise under any patent or patent rights of Jensen Transformers, Inc.

IMPORTANT NOTE: This device is NOT intended for use in life support systems or any application where its failure could cause injury or death. The breakdown voltage specification is intended to insure integrity of internal insulation systems; continuous operation at these voltages is NOT recommended. Consult our applications engineering department if you have special requirements.

JENSEN TRANSFORMERS, INC., 7135 Hayvenhurst Avenue, Van Nuys, CA 91406-3807, USA
(818) 374-5857 • FAX (818) 374-5856 • www.jensen-transformers.com