

**VIDEO GROUND LOOP CORRECTOR  
FOR 75 Ohm SYSTEMS**

- 56dB of CMRR typ at 60Hz minimizes ground loops
- DC to 600MHz bandwidth for excellent picture quality
- Greater than 1 Vrms 60Hz common-mode level handling
- VSWR under 1.1 at 100MHz to prevent waveform distortion
- Insertion loss of 0.05 dB maintains maximum S/N ratio

The ISO-MAX® VBH-1RR reduces ground current induced video interference such as “hum bars” by a factor of over 100, eliminating the visible effects of these types of interference. The high bandwidth and low VSWR prevent degradation of the picture quality due to high frequency roll-off and cable reflections.

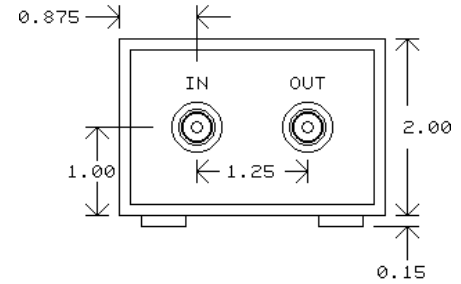
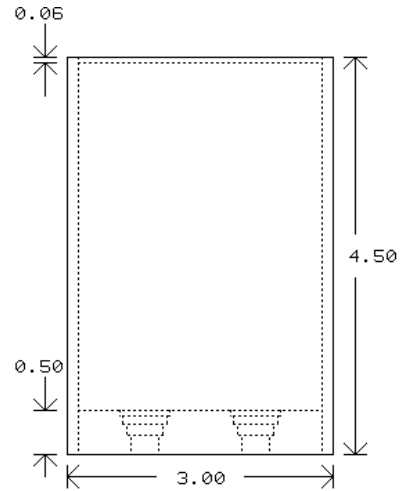

INPUT AND OUTPUT CONNECTOR  
ARE 75 OHM IHF/RCA TYPE

ALL DIMENSIONS IN INCHES

HOUSING IS ELECTRICALLY  
ISOLATED

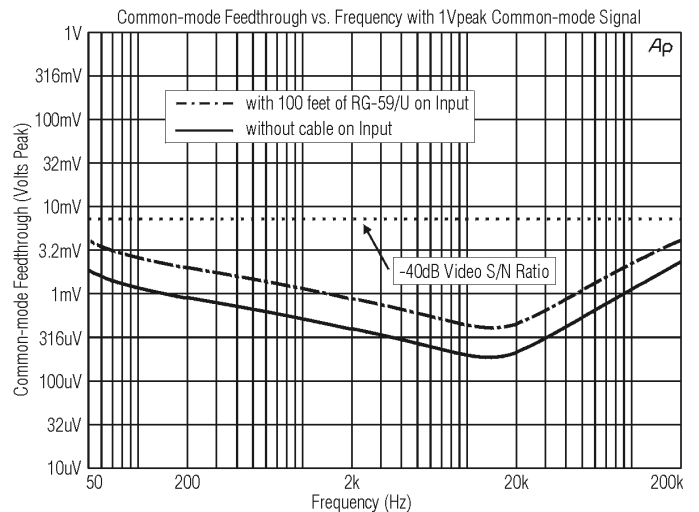
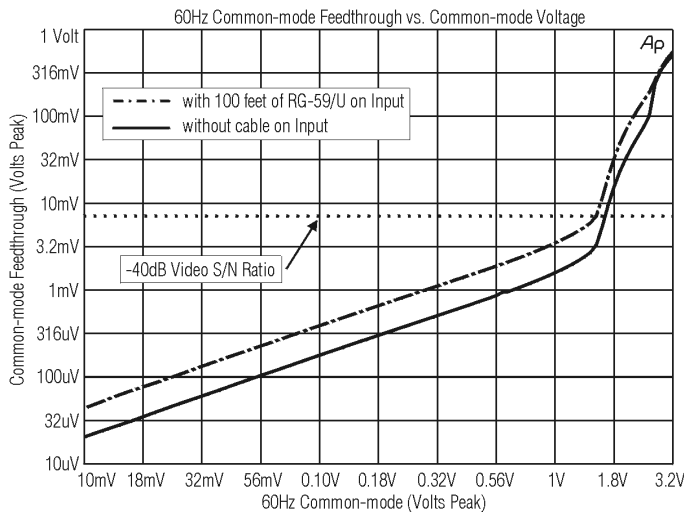

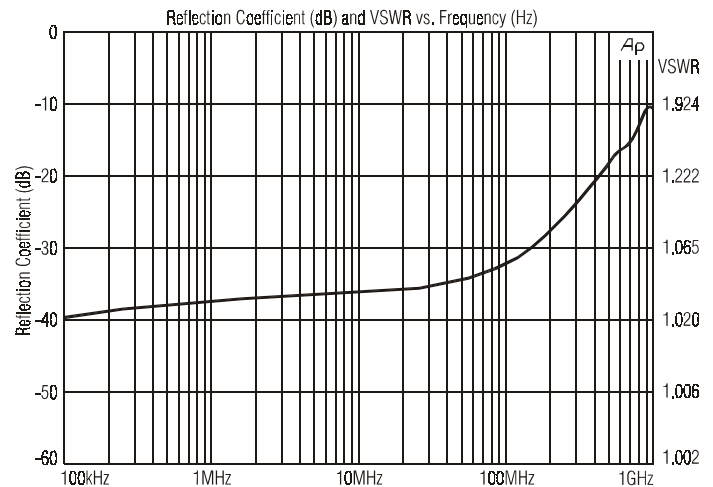
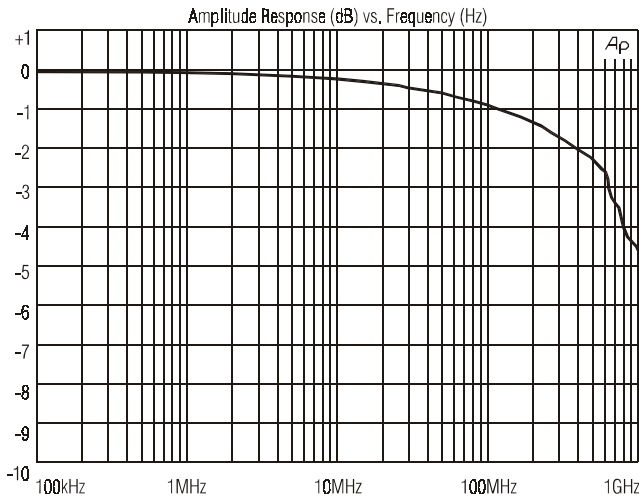

## ISO-MAX® VBH-1RR SPECIFICATIONS

(source Z = load Z = 75 Ohms, signal level = 1Vpp unless otherwise noted)

PARAMETER	CONDITIONS	MINIMUM	TYPICAL	MAXIMUM
Input impedance, Zi	1 0kHz, test circuit 1		75Ω	
Insertion Loss	10 kHz, test circuit 1 (referred to -6.02dB)		-0.05 dB	-0.10 dB
High Frequency Response, ref 10 kHz	100kHz, test circuit 1 (referred to -6.02dB)		-0.005 dB	
	1MHz, test circuit 1 (referred to -6.02dB)		-0.05 dB	
	3.58MHz, test circuit 1 (referred to -6.02dB)		-0.10 dB	
	10MHz, test circuit 1 (referred to -6.02dB)		-0.20 dB	
	100MHz, test circuit 1 (referred to -6.02dB)	-1.00dB	-0.80 dB	
Low Frequency Response	test circuit 1		DC	
Common-mode Rejection Ratio	60 Hz, test circuit 2, no cable	50dB	56dB	
	60 Hz, test circuit 2, with 100 feet of RG-59/U cable at input		48dB	
Maximum Common-mode Voltage	60 Hz, test circuit 3, 3% THD	1.4 Vpeak	1.7 Vpeak	
Inductance	60 Hz, 500mVrms, shield, input to output		200mH	
DC resistance	center conductor, input to output		0.70 Ω	
	shield, input to output		0.20 Ω	
Capacitance	center conductor to shield		200 pF	
Weight			1.65 lbs.	
Temperature range	operation or storage	0° C		70° C

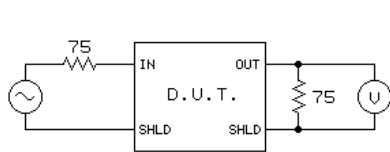

TEST CIRCUIT 1

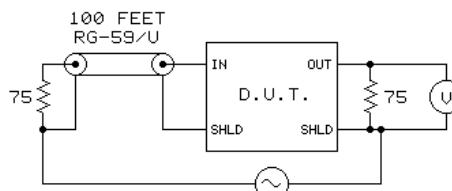

TEST CIRCUIT 2

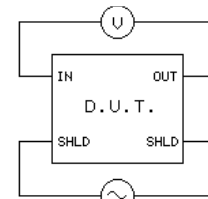

TEST CIRCUIT 3

**All minimum and maximum specifications are guaranteed.** Unless noted otherwise, all specifications apply at 25°C. Specifications subject to change without notice. All information herein is believed to be accurate and reliable, however no responsibility is assumed for its use nor for any infringements of patents which may result from its use. No license is granted by implication or otherwise under any patent or patent rights of Jensen Transformers, Inc.

**JENSEN TRANSFORMERS, INC., 7135 Hayvenhurst Avenue, Van Nuys, CA 91406-3807, USA**